

APPENDIX A

COMBUSTION AIR OPENINGS AND CHIMNEY CONNECTOR PASS-THROUGHS

(This appendix is adopted as part of the code.)

Figures A-1 through A-4 are illustrations of appliances located in confined spaces.

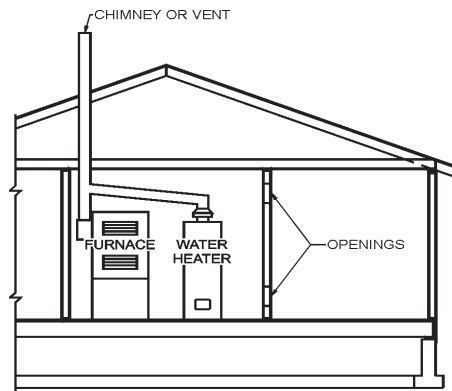

FIGURE A-1
ALL AIR FROM INSIDE THE BUILDING

NOTE: Each opening shall have a free area of not less than 1 square inch per 1,000 Btu per hour of the total input rating of all appliances in the enclosure and not less than 100 square inches.

For SI: 1 square inch = 645 mm², 1 British thermal unit per hour = 0.2931 W.

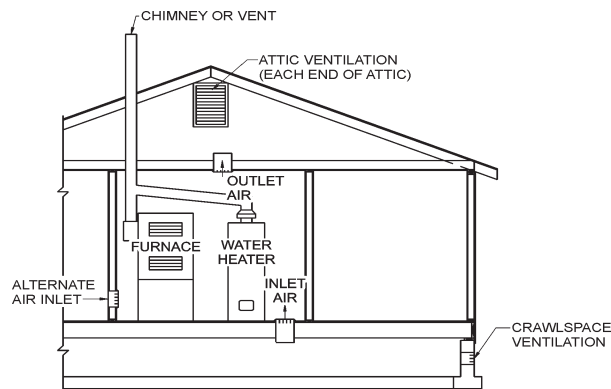
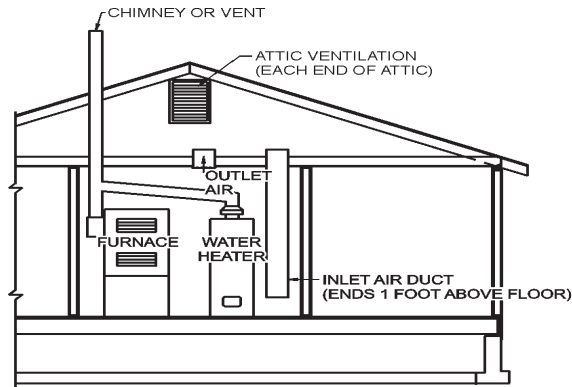

FIGURE A-2
ALL AIR FROM OUTDOORS—INLET AIR FROM VENTILATED CRAWL SPACE AND OUTLET AIR TO VENTILATED ATTIC

NOTE: The inlet and outlet air openings shall each have a free area of not less than 1 square inch per 4,000 Btu per hour of the total input rating of all appliances in the enclosure.

For SI: 1 square inch = 645 mm², 1 British thermal unit per hour = 0.2931 W.



**FIGURE A-3
ALL AIR FROM OUTDOORS THROUGH VENTILATED ATTIC**

NOTE: The inlet and outlet air openings shall each have a free area of not less than 1 square inch per 4,000 Btu per hour of the total input rating of all appliances in the enclosure.

For SI: 1 foot = 304.8 mm, 1 square inch = 645 mm², 1 British thermal unit per hour = 0.2931 W.

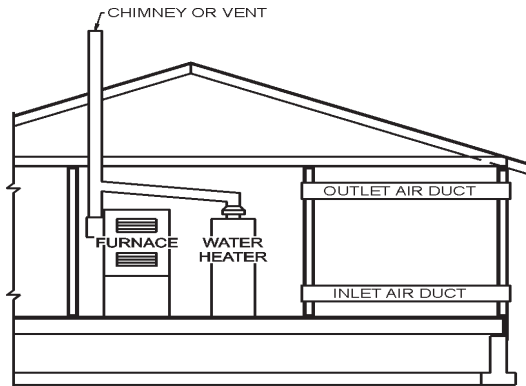

**FIGURE A-4
ALL AIR FROM OUTDOORS THROUGH HORIZONTAL DUCTS OR DIRECT OPENINGS**

NOTE: Each air duct opening shall have a free area of not less than 1 square inch per 2,000 Btu per hour of the total input rating of all appliances in the enclosure. If the appliance room is located against an outside wall and the air openings communicate directly with the outdoors, each opening shall have a free area of not less than 1 square inch per 4,000 Btu per hour or the total input rating of all appliances in the enclosure.

For SI: 1 foot = 304.8 mm, 1 square inch = 645 mm², 1 British thermal unit per hour = 0.2931 W.

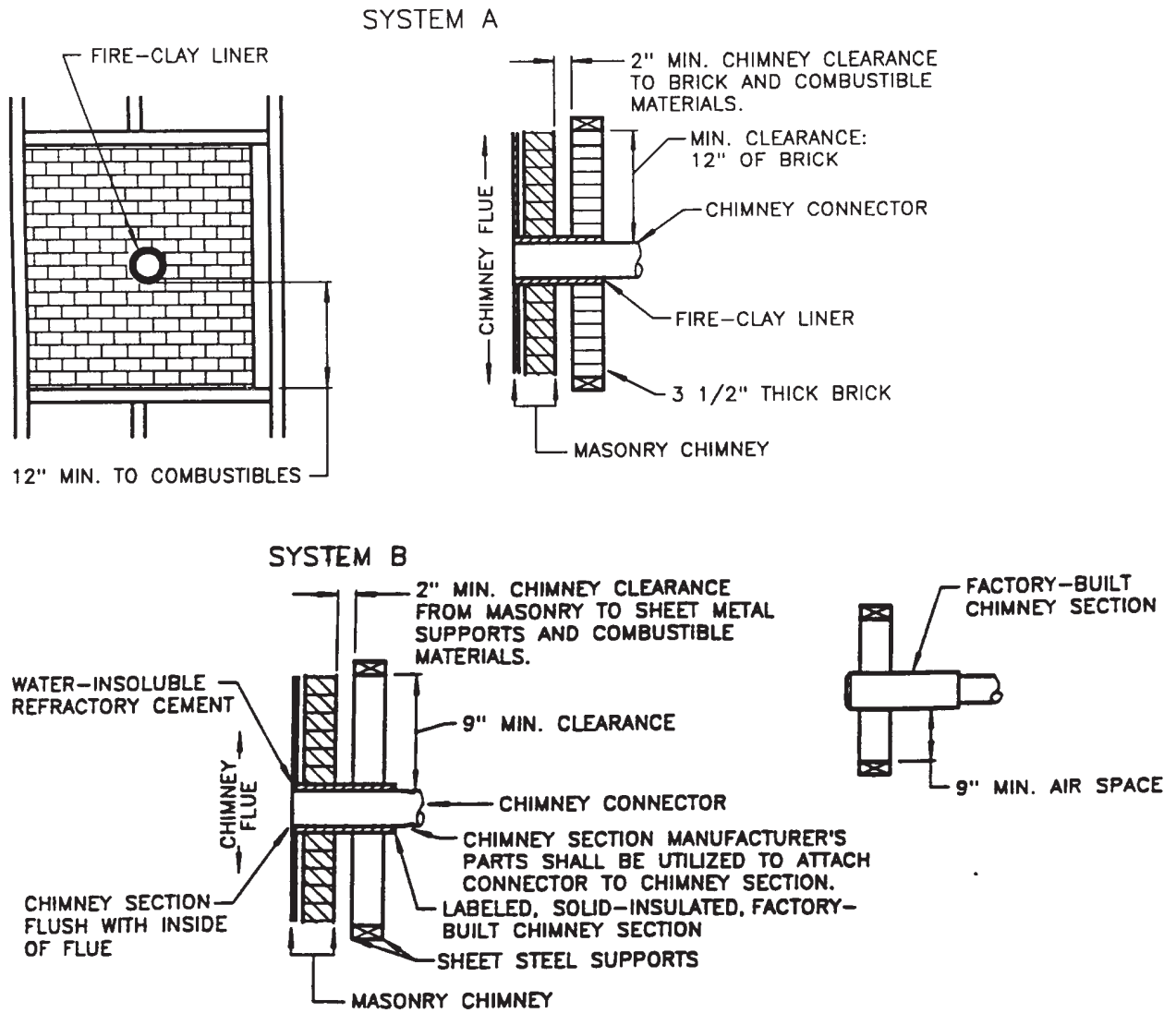

For SI: 1 inch = 25.4 mm.

SYSTEM C

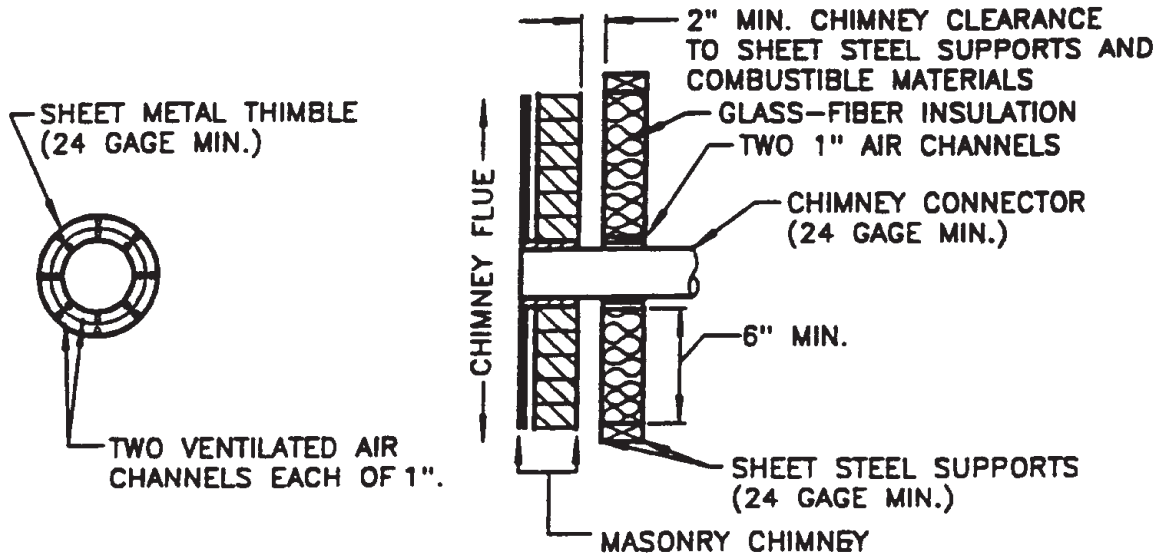

SYSTEM D

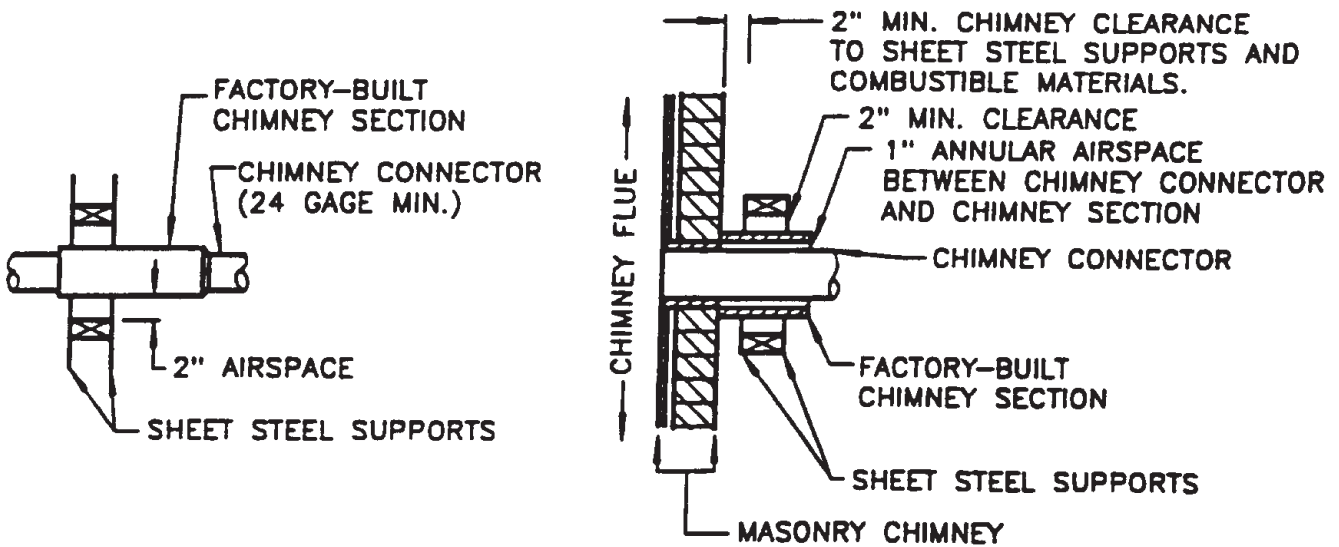

FIGURE A-5—continued
CHIMNEY CONNECTOR SYSTEMS

For SI: 1 inch = 25.4 mm.